

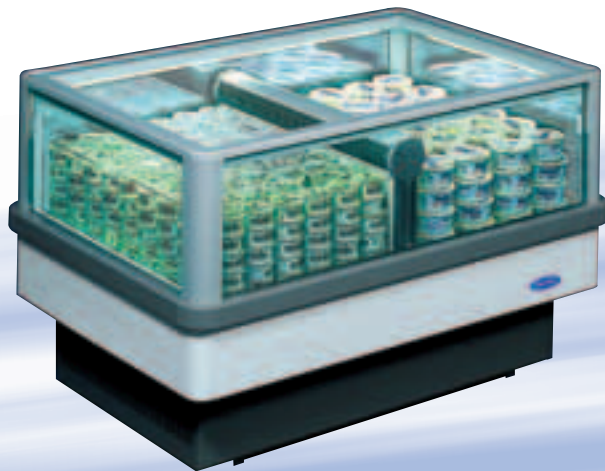

PREMOR 1085/1085 G



PREMOR 1545/85



PREMOR 1585G



PREMOR 2085G

PREMOR 1085

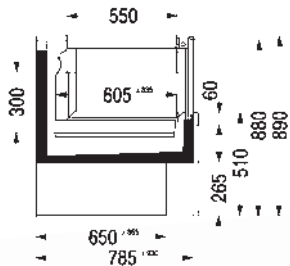

PREMOR 1085 G

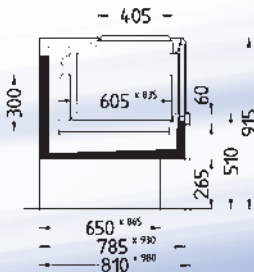

PREMOR 1545/85

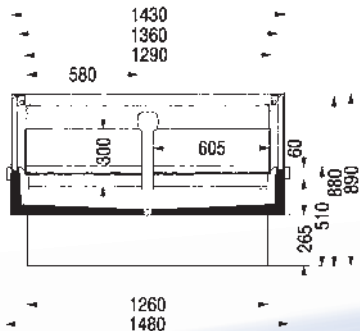

PREMOR 1585 G

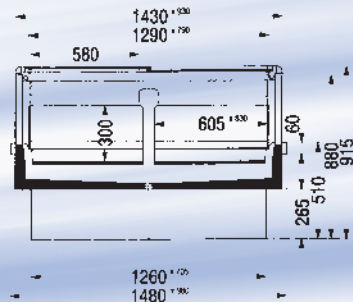



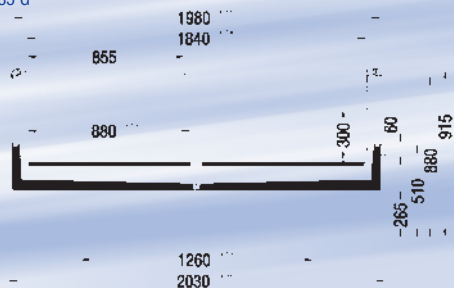

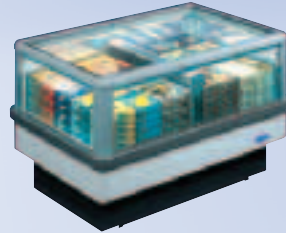
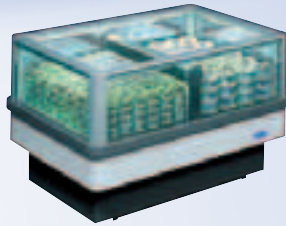
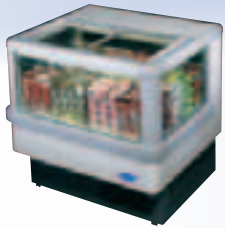













PREMOR 2085 G





PREMOR Technical Data

Model	 Temperature range (°C)	 Volume (ltr.)	 Net weight (kg)	 Dimensions (mm)			 Crated dimensions (mm)			 Crated weight (kg)	  Transport		 Application		
				width	depth	height	width	depth	height		Truck (13,6)	40'cont.			
1085	-18...-23	150	150	980	810	890	1040	960	1130	178	56	48	 		
1085 G			160			915				195			 		
1585 G		-18...-23 / 0...+2	300	260	1480	980	915	1540	1090	1410	280	17	15	 	
1545/85	253			880			270				34			30	  
2085 G	440			312			2030				915			2090	1310