

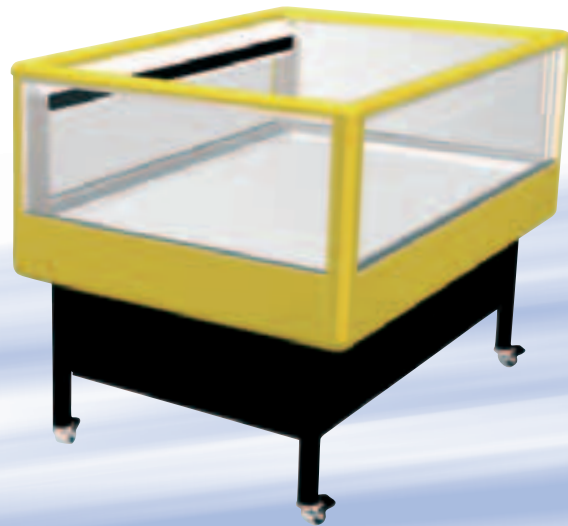

COC11



COC22



COC17

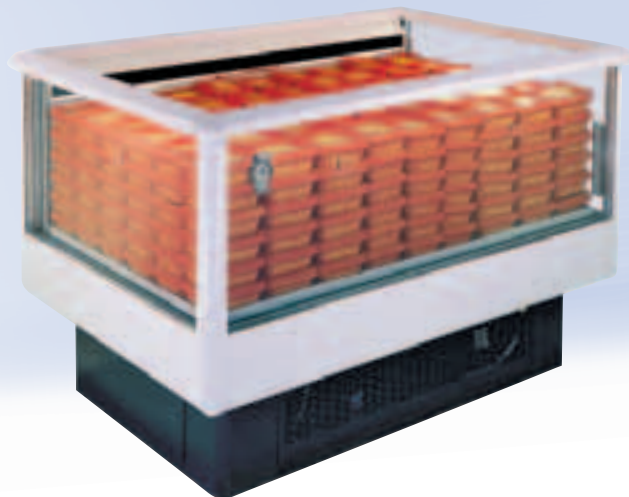

COC33

COC11

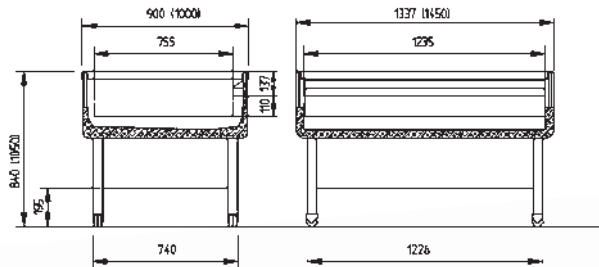

COC17

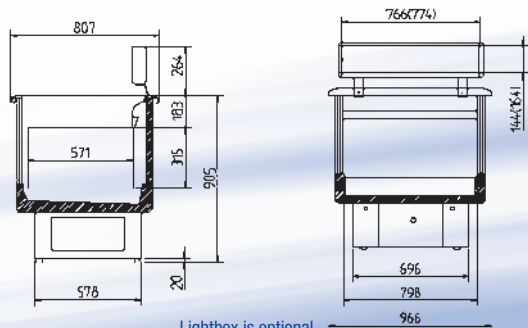

Lightbox is optional

COC22

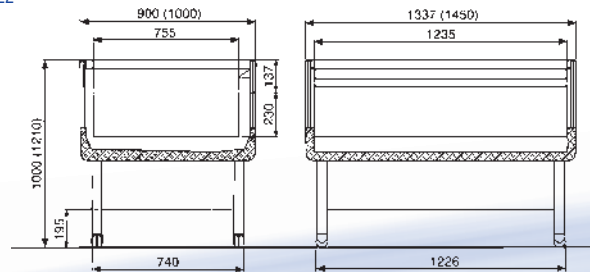

COC33

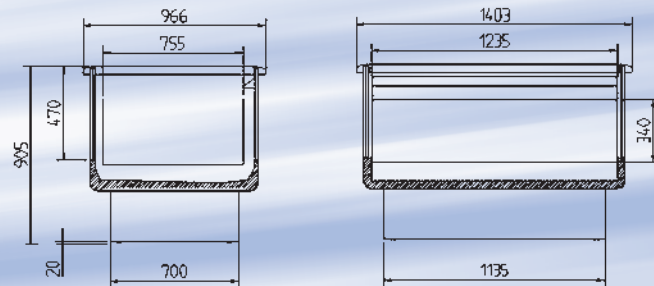

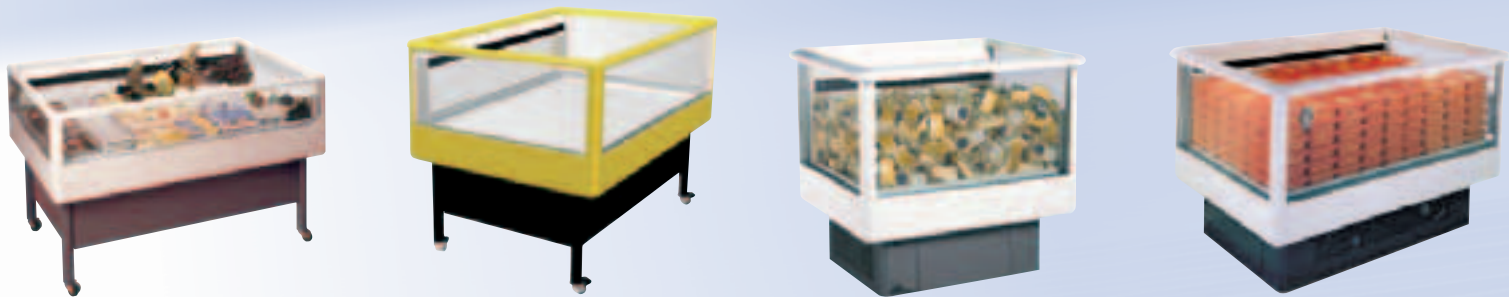

## CRYSTAL Technical Data

Model	Temperature range (°C)	Volume (ltr.)	Net weight (kg)	Dimensions (mm)			Crated dimensions (mm)			Crated weight (kg)	Transport		Application
				width	depth	height	width	depth	height		Truck (13,6)	40'cont.	
COC11	+1...+8	100	170	1337	900	840	1450	1000	1050	185	36	32	
COC22	+2...+8	215	175			1000			1200			190	
COC17	+2...+8	130	105	966	807	905	1050	840	1050	115	64	56	
COC33	+2...+8	320	185	1403	966		1450	1000	1050			200	

\*fully mounted/half mounted | \*\*standard cont./half mounted in HC cont. | \*\*\*standard cont./HC cont.

Islands · Wallsides  
Temp.: +